

BROADCAST[®]
t o o l s **INC**
PROBLEM SOLVED

Installation and Operation Manual



GPI-16+ G2 Net
Sixteen Input General Purpose Interface with USB/Ethernet

Firmware version: 1.01 or greater

Manual Revised 10/25/2023

If you need a firmware upgrade, contact Broadcast Tools[®]

No part of this document may be reproduced or distributed without permission.
ALL SPECIFICATIONS AND FEATURES FOR THIS PRODUCT ARE SUBJECT TO
CHANGE WITHOUT NOTICE

NOTE: We recommend the use of Chrome, Firefox or Safari as your browser.

Due to the dynamic nature of product design, the information contained in this document is subject to change without notice. Broadcast Tools, Inc., assumes no responsibility for errors and/or omissions contained in this document. Revisions of this information or new editions may be issued to incorporate such changes.

*Broadcast Tools[®] is a registered trademark of Broadcast Tools, Inc.
All Sentinel[®] labeled products are registered trademarks of Broadcast Tools, Inc.
Copyright[®] 1989 - 2023 by Broadcast Tools, Inc. All rights reserved.
No part of this document may be reproduced or distributed without permission.*

Visit www.broadcasttools.com for important product update information.

Table of Contents

Section Title	Page #
Introduction	3
Safety Information	3
Who to Contact for Help	3
Product Overview	4
Inspection	5
 Installation	
RFI and surge suppression suggestions	5
UPS Standby Power System	5
Input connections	5
USB connector	5
LAN/NET Ethernet connector (RJ-45)	6
 Configuration	
Terminal setup and start-up	7
Configuration commands	8
 Operation	
PIP information retrieval commands	9
AT1616 information retrieval commands	10
Ethernet Setup and Operation	11
Ethernet “Quick Start” Guide	11
Connecting via the Ethernet	14
Changing network settings	15
Specifications	17
Warranty	18
 Appendix	
Functional diagram	Appendix A
Component layout	Appendix B
Front and rear panel drawings	Appendix C

WEBSITE:
Visit our web site for product updates and additional information.

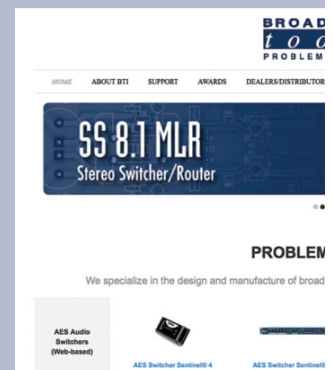

INTRODUCTION

Thank you for your purchase of a Broadcast Tools® GPI-16 + G2 NET, sixteen input general purpose interface (referred to as the GPI-16 + G2 NET throughout this manual). We're confident that this product will give you many years of dependable service. This manual is intended to give you all the information needed to install and operate the Broadcast Tools® GPI-16 + G2 NET.

Broadcast Tools, Inc., is unable to support NON-Broadcast Tools hardware/software and/or NON-Broadcast Tools computer hardware/software problems. If you experience these problems, please research your hardware/software instruction manuals or contact the manufacturers technical support department.

SAFETY INFORMATION

Only qualified personnel should install Broadcast Tools® products. Incorrect or inappropriate use and/or installation could result in a hazardous condition.

WHO TO CONTACT FOR HELP

If you have any questions regarding your product or you need assistance, please contact your distributor from whom you purchased this equipment. If you would like more information about BROADCAST TOOLS® products, you may reach us at:

Broadcast Tools, Inc.

131 State Street
Sedro-Woolley, WA 98284-1503 USA
Voice: 360.854.9559
Fax: 866.783.1742

Internet Home Page: www.broadcasttools.com
E-mail: support@broadcasttools.com

THANK YOU FOR CHOOSING
BROADCAST TOOLS® BRAND PRODUCTS!

Broadcast Tools is a Veteran Owned Business



Designed, Assembled and Supported in WA State, USA



Broadcast Tools® Products, as with any electronic device, can fail without warning. Do not use this product in applications where a life threatening condition could result due to failure.



This manual should be read thoroughly before installation and operation.

WEBSITE:

Visit our web site for product updates and additional information.

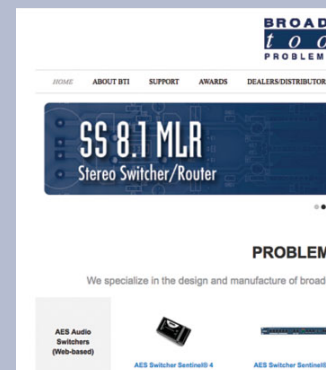

Product Overview

The GPI-16 + G2 NET interfaces 16 general purpose logic inputs to users USB port or Ethernet network. The user may select from two pre-programmed serial formats; the “PIP” GPI trigger format which is used on most Broadcast Tools audio switchers, or the legacy AT-1616 format. Additional features include; Plug-in euroblock screw terminals; 17 LED indicators for power and each input status.

Features/Benefits

- Four user selectable unit ID's: 0 (default), 1,2, and 3.
- Four user selectable baud rates: 9600 (default), 4800, 19200, and 38400.
- PIP or AT1616 data format.
- USB and Ethernet (TCP or UDP) interface for connection to PC.
- LED indicators for all 16 inputs, power.
- GPI connections are on removable euro-block screw terminal connector to simplify wiring and service, mating plugs are supplied.
- Fully RFI proofed.
- Surge protected internal power supply, 9 VDC universal desktop power adapter with IEC inlet included.
- Up to three units may be mounted on the optional RA-1 rack shelf, using four supplied Velcro feet. Desktop and wall mounting are also possible.

WEBSITE:

Visit our web site for product updates and additional information.

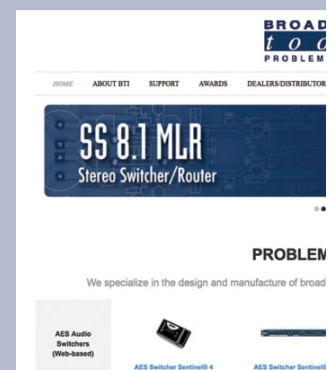

Inspection

Please examine your GPI-16 + G2 NET carefully for any damage that may have been sustained during shipping. If any is noted, please notify the shipper immediately and retain the packaging for inspection by the shipper. The package contains the GPI-16 + G2 NET, a USB type A/B cable, a 7-foot BLUE straight-through CAT 5 cable, a 7-foot GRAY crossover CAT 5 cable, and a 9.0 VDC universal desktop power supply with IEC AC inlet. Manuals may be downloaded from our web site.

Installation

Power

Connect the 2.1mm barrel type center positive power connector into the unit and the 9 VDC power supply with IEC inlet into a 120 Vac 50-60 Hz power source.

NOTE: Never use any type of power supply other than the specified/supplied power supply. Check the power jack on the back of the unit to determine which power supply is required.

UPS Standby Power System

We recommend that you connect your GPI-16 + G2 NET to a UPS standby power system. A UPS, like the BE600M1 from APC helps to minimize the risk to the GPI-16 + G2 NET and provides power during a power outage.

Input connections

The sixteen general purpose inputs may be activated by either pulling the input to ground or releasing the input to a high state. A valid input must be 15ms in duration or greater. External sources can be contact closures, open collectors or 5-to-24-volt logic level sources. The impedance of each input is 22K ohms.

Input connections are via a single 18-position plug-in euroblock screw terminal that is labeled "Inputs" 1 thru 16 with ground connections on terminals 17 and 18. To install, remove the plug from the header, strip 1/8" of insulation from the wire. Insert the wire into the desired terminal and tighten the set screw. When finished, reinsert the plug into the header.

USB Port

This type B USB port is used to connect the GPI-16 + G2 NET to a computer's USB port using the included USB A/B cable. When you first plug the GPI-16 + G2 NET into your PC, it should automatically install the correct FTDI USB Serial "Virtual COM port" driver which will allow you to access the GPI-16 + G2 NET on a COM port. If the GPI is being used for Ethernet operation this should remain disconnected, and the drivers are not necessary.

NOTE: If the GPI-16 + G2 NET's FTDI USB Serial "Virtual COM port" drivers do not automatically install they may be downloaded by clicking on the "setup executable" link found here: <http://www.ftdichip.com/Drivers/VCP.htm>



Installation of the GPI-16 + G2 NET in high RF environments should be performed with care. It is recommended that all cables connected to the GPI-16 + G2 NET be looped through ferrite cores to suppress RF. Surge protection with RF filtering is also suggested for the power supply. For lightning protection devices, check out www.polyphaser.com and www.itwlinx.com.

WEBSITE:

Visit our web site for product updates and additional information.

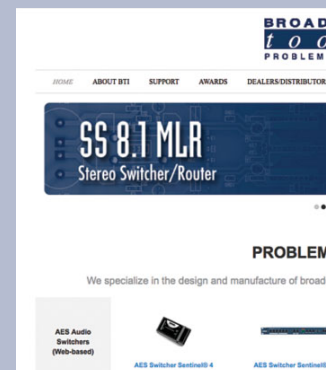

INSTALLATION

LAN/NET Ethernet Port

This 10/100 Ethernet port is used to connect the GPI-16 + G2 NET to a computer for configuration and control via telnet/TCP socket connections. See the “Ethernet” and “Programming” sections of this manual for more information.

Resetting Ethernet Settings to Defaults

Defaults may be restored by depressing the recessed front panel Def. (Defaults) push button, applying power to the unit, and holding down the push button for five seconds after power up.

WEBSITE:

Visit our web site for product updates and additional information.

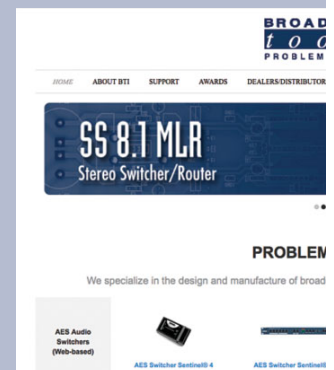

Configuration

The GPI-16 + G2 NET can be connected to your computer by one of two interfaces; USB, or RS-232 serial. Below are connection and configuration instructions for each interface.

NOTE: Step by step “COM” port HyperTerminal setup instructions are available on-line at www.broadcasttools.com under “Downloads”.

Configuration via the USB Port.

1. Connect the supplied USB A/B cable from the “USB” jack on the GPI-16 + G2 NET to an available USB port on your PC. When you first plug the GPI-16 + G2 NET into your PC, it should automatically install the correct FTDI USB Serial “Virtual COM port” driver which will allow you to access the GPI-16 + G2 NET on a COM port. Once you've installed the driver, the GPI-16 + G2 NET will be listed as “USB Serial Port” in device manager.

NOTE: If the GPI-16 + G2 NET’s FTDI USB Serial “Virtual COM port” drivers do not automatically install they may be downloaded by clicking on the “setup executable” link found here: <http://www.ftdichip.com/Drivers/VCP.htm>

2. Start a serial terminal application like Tera Term, PuTTY or HyperTerminal configured for the USB COM port the GPI-16 + G2 NET is assigned to at 9600 baud,8,N, 1, flow control to NONE, Emulation set to ANSI, and local character echo enabled.

3. Connect the supplied 9 VDC power supply connector in to the GPI-16 + G2 NET’s power jack labeled “9-12VDC”, then plug the power supply in to a power source. Verify that the green “PWR/HB” led is blinking. The unit information should be displayed on your monitor if things are setup and/or working properly.

Configuration via the Ethernet Port.

See the “Ethernet Setup and Operation” section of this manual for instructions.

WEBSITE:

Visit our web site for product updates and additional information.

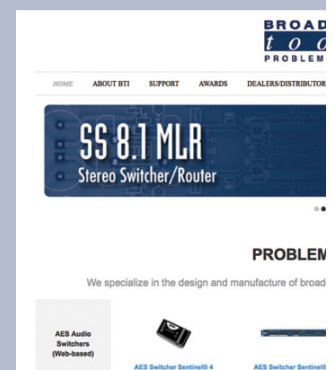

Configuration Commands

If you plan on using the default settings disregard this page of the manual. If you require changes to the default settings, follow the steps below to configure the GPI-16 + G2 NET from your computer.

To modify the default configuration, execute the following command:

*uSUxyz where “u” is the current unit ID, “x” is configuration item 1, “y” is configuration item 2, and “z” is configuration item 3. No carriage return or line feed is required. NOT case sensitive.

Command example: *0SU030 would set the unit ID to zero, baud rate to 38400 and serial format to PIP.

To query the current configuration, execute the following command:

*ASU? No carriage return or line feed is required. NOT case sensitive.

Command example: *ASU?

Response example: *ASU? where the A would respond to the current configured Unit ID, then the three current configuration characters xyz.

Configuration Item 1 (unit ID = x): Enter the desired unit ID number:

- 0 = (NON-Polling). (default)
- 1 = Polling
- 2 = Polling
- 3 = Polling

Configuration Item 2 (baud rate = y): Enter the desired baud rate number:

- 0 = 9600 (default)
- 1 = 19200
- 2 = 4800
- 3 = 38400

Configuration Item 3 (serial format mode = z): Enter the desired serial format number:

- 0 = PIP format (default)
- 1 = AT1616 format

NOTE: To reset these settings to factory defaults. Pull input 16 low TWO to THREE times within 5 seconds during repowering the unit. The PWR/HB will flash rapidly indicating the defaults have been loaded.

WEBSITE:

Visit our web site for product updates and additional information.

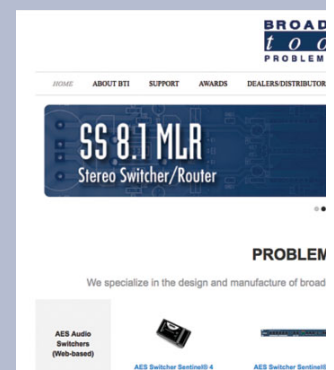

AT1616 Information Retrieval Commands

In AT1616 format mode the GPI-16 + G2 NET sends a response string in AT1616 format each time an input changes state. In AT1616 format mode the unit ID is setting is ignored and the baud rate is fixed at 9600.

Each string consists of a dash (-) followed by 8 bytes. The first 4 bytes are ASCII hex representations of the 16 outputs which are not included in the GPI-16 + G2 NET, but are issued as all zeros.

The last four bytes represent the 16 inputs in ASCII hex format with four bytes: 16,15,14,13 12,11,10,9 8,7,6,5 4,3,2,1. If inputs 1,4,7,8,9,10,14,16 are all ON (pulled to ground), then these four bytes would appear as: A3C9. In the above example, the complete string would be -0000A3C9

Additional response examples:

Response string example for input 1 pulled low: -00000001
Response string example for input 1 returning high: -00000000

Response string example for input 2 pulled low: -00000002
Response string example for input 2 returning high: -00000000

Response string example for input 3 pulled low: -00000004
Response string example for input 3 returning high: -00000000

Response string example for input 4 pulled low: -00000008
Response string example for input 4 returning high: -00000000

Response string example for input 16 pulled low: -00008000
Response string example for input 16 returning high: -00000000

Response string example for inputs 1 thru 8 pulled low: -00000055
Response string example for input 1 thru 8 returning high: -00000000

Response string example for inputs 9 thru 16 pulled low: -00005500
Response string example for input 9 thru 16 returning high: -00000000

WEBSITE:

Visit our web site for product updates and additional information.

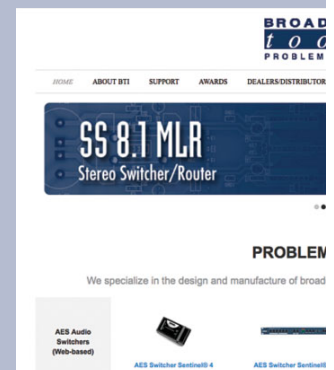

Ethernet Setup and Operation

Ethernet “Quick Start” Guide

CAUTION! NEVER DOWNLOAD FIRMWARE UPDATES OR CHANGES TO THE WEB SERVER UNLESS INSTRUCTED TO DO SO BY BROADCAST TOOLS®. DOING SO DELETES ALL SOFTWARE AND VOIDS ALL WARRANTIES FROM BROADCAST TOOLS, INC.

CAUTION! If you are not familiar with Ethernet enabled equipment, it may be useful to contact your IT department, network administrator or network consultant for assistance. Assigning an IP address already in use by another device may cause problems with your network!

Instructions for changing the IP address of the computer that will be used for the configuration of this product are given here. Note that these instructions are specifically for computers with the Windows 10 operating system but will also work with Windows 7. For setup using other operating systems, refer to the appropriate OS user’s manual.

Step 1: Open the control panel by clicking on the Start Menu, click on Settings, then click on Network & Internet.

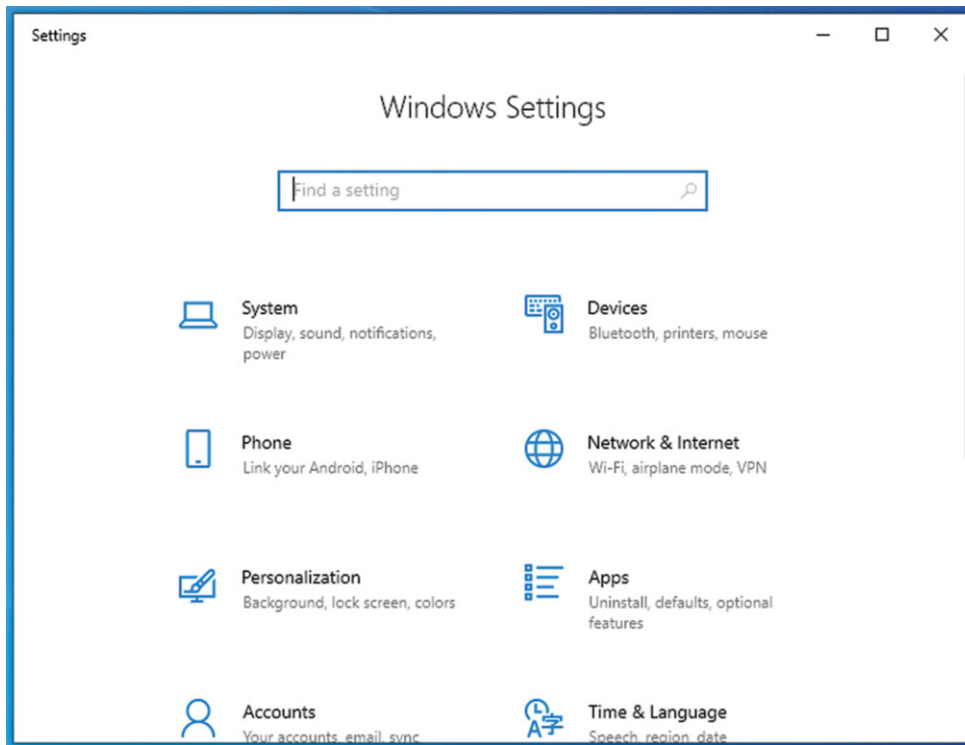

WEBSITE:

Visit our web site for product updates and additional information.

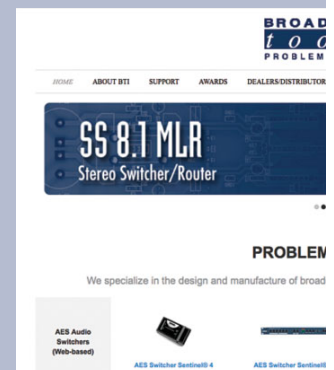

Step 2: Under Advanced Network Settings click Change adapter settings. The Network Connections windows will pop up, as shown below.

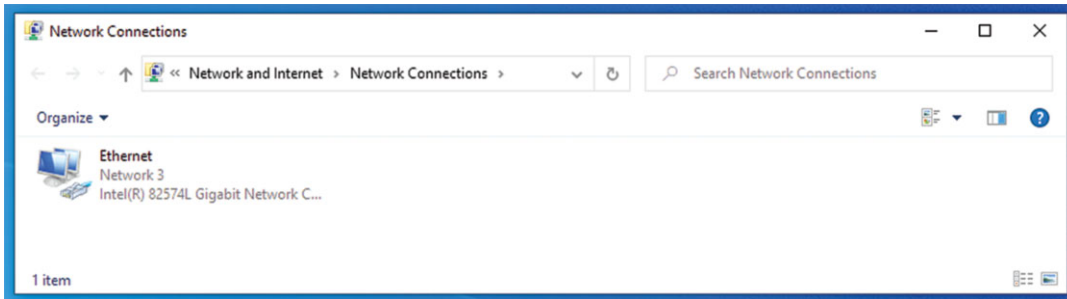

Step 3: Right click on the icon labeled Local Area Connection or Ethernet. A menu will appear. Select the option at the bottom of the menu labeled Properties. The Ethernet Properties window will appear.

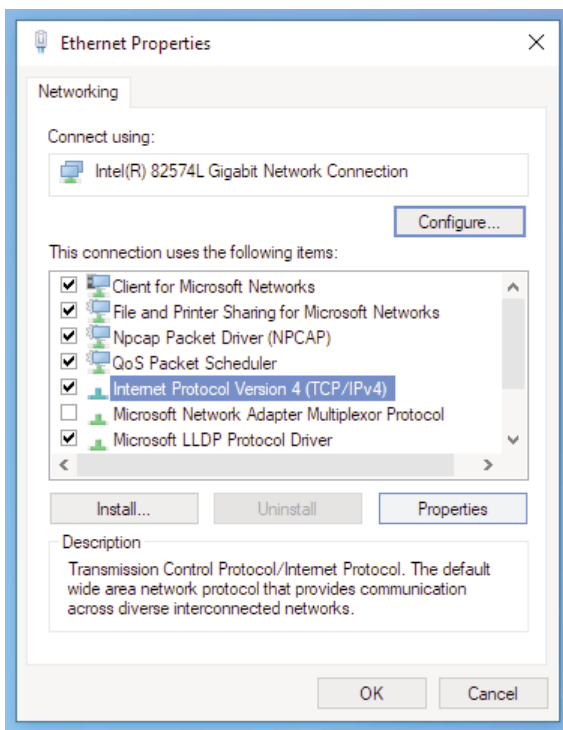

WEBSITE:

Visit our web site for product updates and additional information.

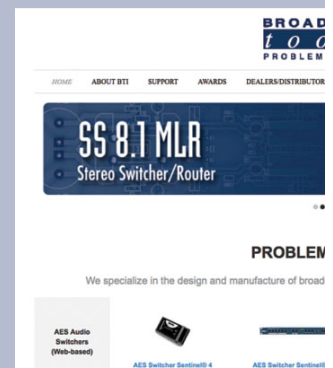

Step 4: On the Local Area Connection Properties page, double click on Internet Protocol (TCP/IPv4) to display properties.

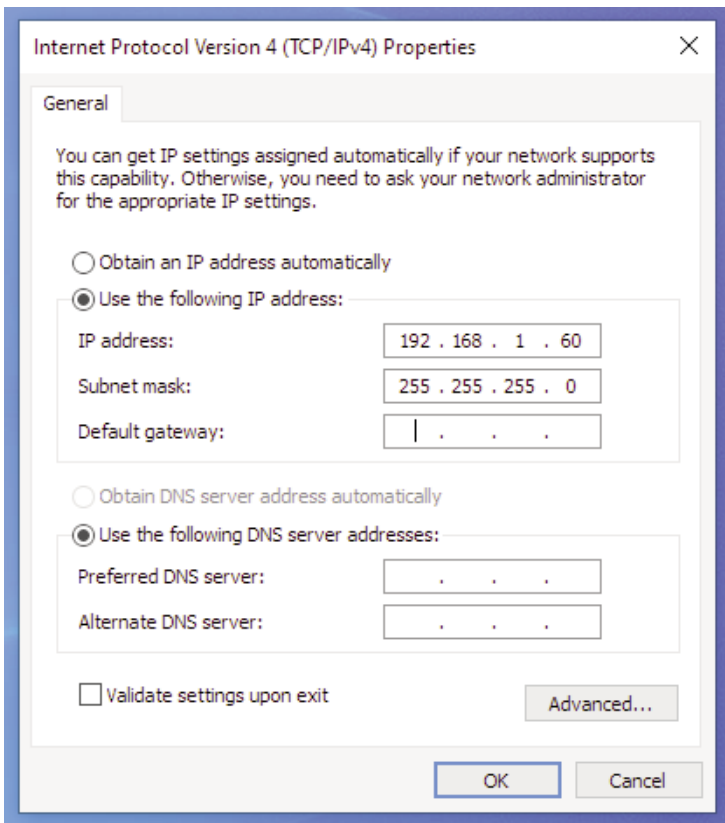

Step 5: Before making any changes to the network settings, write down the current settings (or screen capture the page and print) so that they can be restored once the unit is configured. Next, select the radio button labeled “Use the following IP address” and type in the IP address 192.168.1.60. Type in the subnet mask of 255.255.255.0. Leave the default gateway field blank. Click OK to apply the new settings.

WEBSITE:

Visit our web site for product updates and additional information.

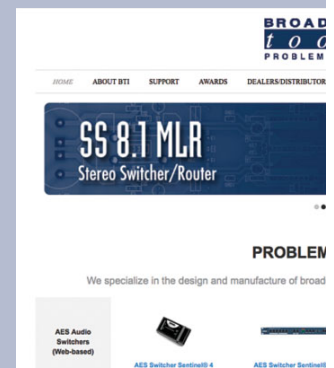

Connecting via the Ethernet “LAN/NET” port:

1. Connect the supplied GRAY colored XOVER cable between the PC’s Ethernet port and the products “LAN/NET” network RJ45 jack.
2. Connect the included power supply to the GPI-16+G2 NET. Verify that the green PWR LED is lit and the green “LINK” LED to the left of the “LAN/NET” Network RJ45 jack is illuminated.
3. Open terminal application PuTTY configured for a Telnet connection type to host 192.168.1.55 port 8001.

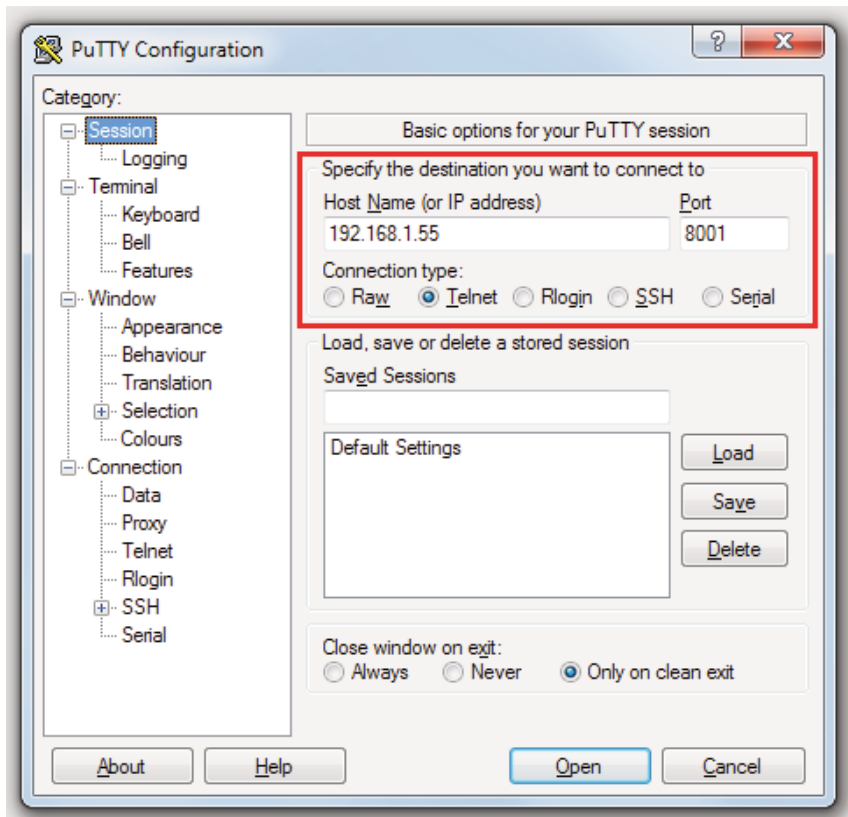

WEBSITE:

Visit our web site for product updates and additional information.

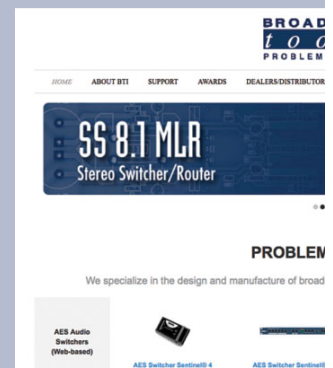

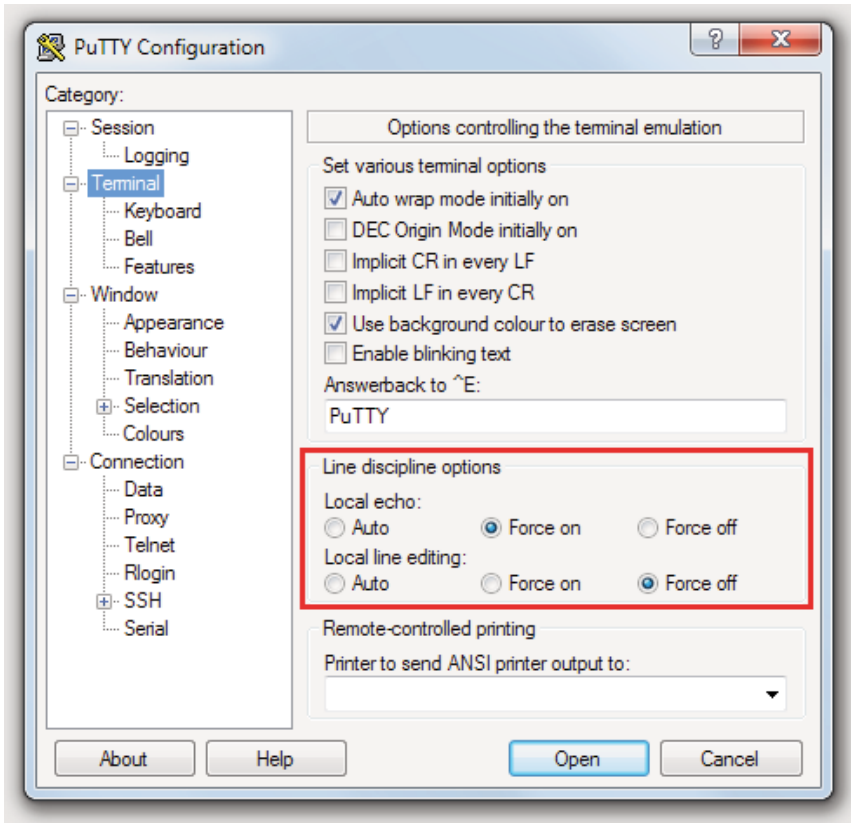

4. In PuTTY configuration > Terminal > Line discipline options set Local echo “Force on” and Local line editing to “Force off”.

5. Click okay to connect to the GPI-16+G2 NET and type “p” into the terminal window and press return to enter programming mode. See: “Programming Steps” section of this manual.

Changing network settings on the Ethernet “LAN/NET” port:

NOTE: We recommend the use of Chrome, Firefox, or Safari for as your browser.

1. Connect the supplied GRAY colored XOVER cable between the PC’s Ethernet port and the products “LAN/NET” network RJ45 jack.
2. Connect the included power supply to the GPI-16+G2 NET. Verify that the green PWR LED is lit and the green “LINK” LED to the left of the “LAN/NET” Network RJ45 jack is illuminated.
3. Open a web browser window and navigate to the GPI-16 + G2 NET’s default IP address: <http://192.168.1.55>
4. When prompted to login, use the default login and password. Login: admin Password: 1234
5. To change the network settings, choose “Local IP Config” from the side bar:

WEBSITE:

Visit our web site for product updates and additional information.

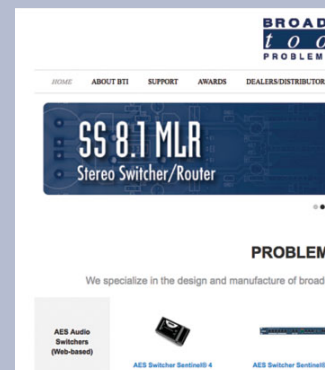

OPERATION

6. The default work mode is TCP Server, TCP Client, UDP Server and UDP Client are also available. To change the TCP port choose “Serial Port” from the side bar and change the “Local Port Number” setting:

Current Status	parameter
Local IP Config	IP type: <input type="text" value="Static IP"/>
Serial Port	DNS type: <input type="text" value="Manual"/>
Expand Function	Static IP: <input type="text" value="192"/> . <input type="text" value="168"/> . <input type="text" value="1"/> . <input type="text" value="55"/>
Misc Config	Submask: <input type="text" value="255"/> . <input type="text" value="255"/> . <input type="text" value="255"/> . <input type="text" value="0"/>
Reboot	Gateway: <input type="text" value="192"/> . <input type="text" value="168"/> . <input type="text" value="1"/> . <input type="text" value="1"/>
	DNS Server: <input type="text" value="8"/> . <input type="text" value="8"/> . <input type="text" value="8"/> . <input type="text" value="8"/>
	<input type="button" value="Save"/> <input type="button" value="Cancel"/>

7. To save changes click “Save” then when prompted click "Restart Module” and “Ok” to reboot the web server module and allow the changes to take effect.

Current Status	parameter
Local IP Config	Baud Rate: <input type="text" value="9600"/> bps(600~460.8K)
Serial Port	Data Size: <input type="text" value="8"/> bit
Expand Function	Parity: <input type="text" value="None"/>
Misc Config	Stop Bits: <input type="text" value="1"/> bit
Reboot	<div style="border: 2px solid red; padding: 2px;"> Local Port Number: <input type="text" value="8001"/> (1~65535) </div>
	Remote Port Number: <input type="text" value="8234"/> (1~65535)
	Work Mode: <input type="text" value="TCP Server"/>
	Remote Server Addr: <input type="text" value="192.168.1.57"/> [192.168.0.201]
	RESET: <input type="checkbox"/>
	LINK: <input type="checkbox"/>
	INDEX: <input type="checkbox"/>
	Similar RFC2217: <input checked="" type="checkbox"/>
	<input type="button" value="Save"/> <input type="button" value="Cancel"/>

WEBSITE:
 Visit our web site for product updates and additional information.

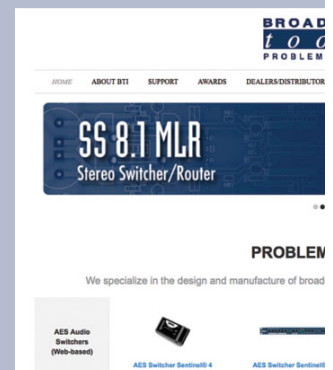

Specifications:

GPI Inputs	The sixteen general purpose inputs activated either by pulling the input to ground or releasing the input to a high state. A valid input must be greater than 15ms in duration. External sources can be contact closures, open collectors or 5 to 24 volt logic level sources. Input impedance is 22K ohms (contact current per input 0.250 ma at 5 volts DC).
GPI Indicators	Sixteen LEDs indicating when an input is on or off. When the LED is illuminated, the input is grounded/on.
Input Interfacing	18-position plug-in euroblock screw terminals. Plug supplied.
USB Port:	USB type B connector. FTDI USB-to-serial chipset, 4800, 9600, 19200, 38400 baud, 8 data bits, no parity, 1 stop bit. Handshaking disabled.
RS-232 Serial Port	RJ11 connector. 4800, 9600, 19200, 38400 baud, 8 data bits, no parity, 1 stop bit. Handshaking disabled. A reverse modular cable with 9-pin "S9" female D-sub adapter is included.
Logic	Flash Microprocessor w/non-volatile memory
Power	9-12 VDC, greater than 500 mA. 2.1mm ID x 5.5mm OD coaxial connector, center positive, surge protected. Universal switching power supply with IEC AC inlet supplied.
Power Indicator	Green LED, indicator will blink indicating proper operation.
Dimensions	6 x 5.25 x 1.63 in (W x L x H)
Weight	2 pounds
Operating Environment:	32°F/0°C-122°F/50°C; 0%-95% non-condensing relative humidity; 10,000ft/3048m.
Options	RA-1 Rack Shelf. 1 RU. Accommodates up to 3 units, filler panels supplied. Note: Velcro is provided to secure the product to the RA-1 shelf. DBM-1 DIN rail mounting bracket.

WEBSITE:

Visit our web site for product updates and additional information.

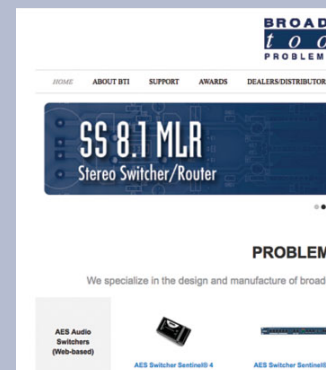

SPECIFICATIONS

LIMITED WARRANTY

The term “Buyer” as used in this document refers to and includes both (but only) (a) any person or entity who acquires such an item for the purpose of resale to others (i.e., a dealer or distributor of an item), and (b) the first person or entity who acquires such an item for such person’s or entity’s own use.

Broadcast Tools warrants to each Buyer of any item manufactured by Broadcast Tools that the item will be free from defects in materials and workmanship at the time it is shipped by Broadcast Tools if the item is properly installed, used and maintained.

EXCLUSIVE REMEDIES

If Broadcast Tools is notified, in writing, of a failure of any item manufactured by Broadcast Tools to conform to the foregoing Limited Warranty within one (1) year following the date of the Buyer’s acquisition of the item, and if the item is returned to Broadcast Tools in accordance with Broadcast Tools’ instructions for confirmation by inspection of the defect (which at Broadcast Tools’ election may include, without limitation, a requirement that the Buyer first obtain a Return Authorization number from Broadcast Tools, that the Buyer furnish proof of purchase in the form of an invoice and/or receipt, and that the Buyer prepay all freight charges associated with any return of the item to Broadcast Tools using such freight service as Broadcast Tools reasonably may specify), Broadcast Tools will repair or replace the defective item, or will refund the purchase price paid by the Buyer for the item. Broadcast Tools shall have the exclusive right to choose between these alternative remedies.

NO OTHER WARRANTIES OR REMEDIES

TO THE MAXIMUM EXTENT PERMITTED BY APPLICABLE LAW, BROADCAST TOOLS AND ITS SUPPLIERS DISCLAIM ALL OTHER WARRANTIES, EITHER EXPRESS OR IMPLIED, INCLUDING BUT NOT LIMITED TO IMPLIED WARRANTIES OF MERCHANTABILITY OR FITNESS FOR A PARTICULAR PURPOSE; AND THE FOREGOING ALTERNATIVE REMEDIES SHALL BE EXCLUSIVE OF ALL OTHER REMEDIES. THIS LIMITED WARRANTY GIVES YOU SPECIFIC LEGAL RIGHTS. YOU MAY HAVE OTHER RIGHTS, WHICH VARY FROM STATE/JURISDICTION TO STATE/JURISDICTION.

NO LIABILITY FOR CONSEQUENTIAL DAMAGES

TO THE MAXIMUM EXTENT PERMITTED BY APPLICABLE LAW, NEITHER BROADCAST TOOLS NOR ANY OF ITS SUPPLIERS SHALL HAVE ANY LIABILITY FOR ANY SPECIAL, INCIDENTAL, INDIRECT, CONSEQUENTIAL OR PUNITIVE DAMAGES WHATSOEVER (INCLUDING, WITHOUT LIMITATION, ANY DAMAGES FOR LOST PROFITS, BUSINESS INTERRUPTION, LOSS OF DATA OR INFORMATION, COST OF CAPITAL, CLAIMS OF CUSTOMERS, OR ANY OTHER PECUNIARY LOSS) ARISING OUT OF THE USE OF OR THE INABILITY TO USE ANY ITEM SUPPLIED BY BROADCAST TOOLS, EVEN IF BROADCAST TOOLS HAS BEEN ADVISED OF THE POSSIBILITY OF SUCH DAMAGES HAVE ANY LIABILITY FOR ANY SPECIAL, INCIDENTAL, CONSEQUENTIAL, EXEMPLARY OR PUNITIVE DAMAGES. THIS LIMITATION OF LIABILITY APPLIES WHETHER A CLAIM IS ONE ALLEGING BREACH OF A CONTRACT OR WARRANTY, NEGLIGENCE OR OTHER TORT, FOR THE VIOLATION OF ANY STATUTORY DUTY, THE FAILURE OF ANY LIMITED OR EXCLUSIVE REMEDY TO ACHIEVE ITS ESSENTIAL PURPOSE, OR ANY OTHER CLAIM OF ANY NATURE. BECAUSE SOME STATES AND JURISDICTIONS DO NOT ALLOW THE EXCLUSION OR LIMITATION OF LIABILITY FOR INCIDENTAL OR CONSEQUENTIAL DAMAGES, THIS LIMITATION MAY NOT APPLY TO YOU.

Broadcast Tools, Inc.

131 State Street
Sedro-Woolley, WA 98284 • USA

360.854.9559 **voice** • 866.783.1742 **fax**
support@broadcasttools.com **e-mail**
www.broadcasttools.com **website**

Functional Diagram

The 16 status / logic inputs may be activated either by pulling the input to ground or releasing the input to a high state. External sources can be contact closures, open collectors or 5, 12, 15 and 24-volt logic-level sources. The input impedance of each input is 22 K ohms. Supplied with Plug-in euroblock connectors.

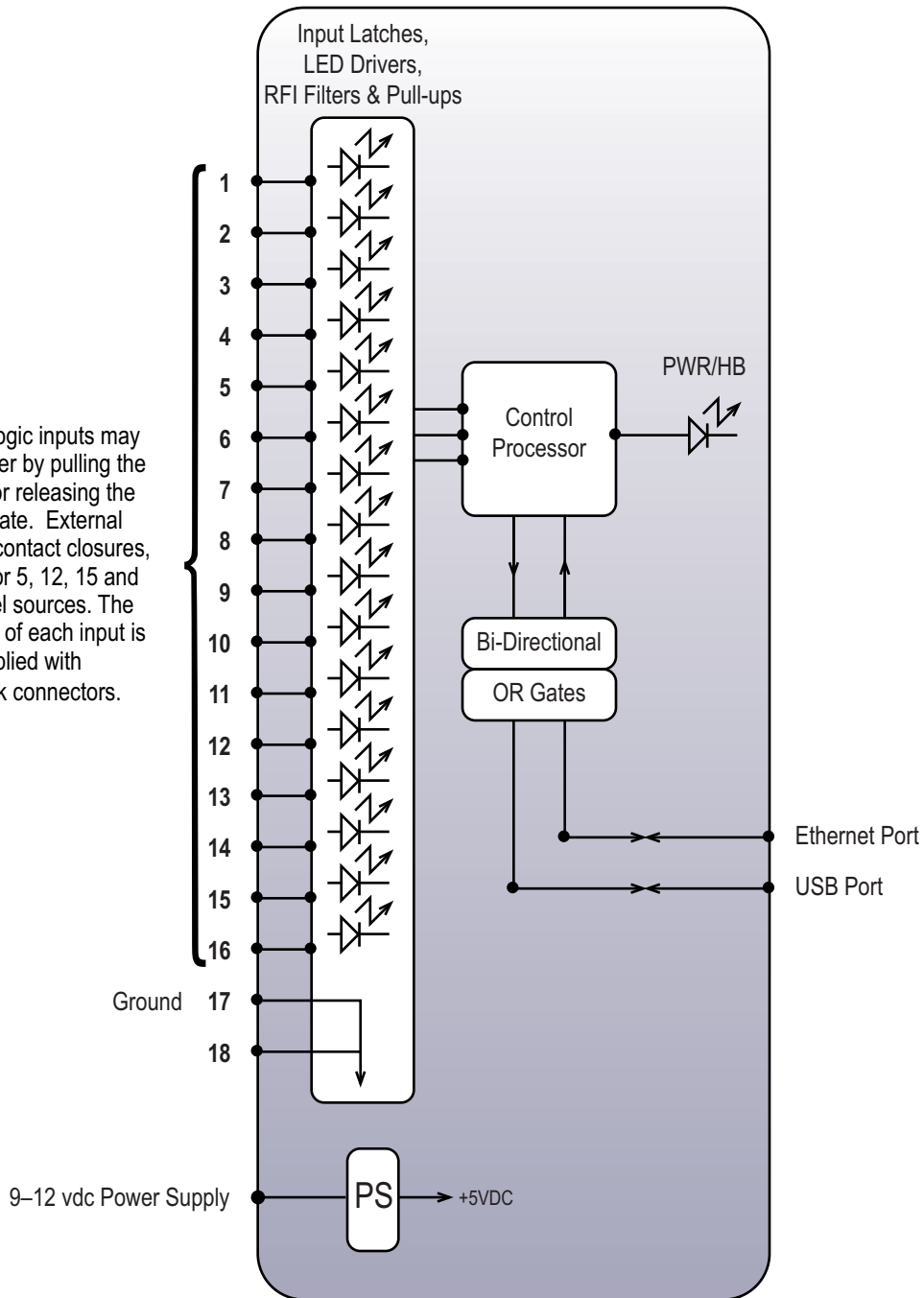

Component Layout

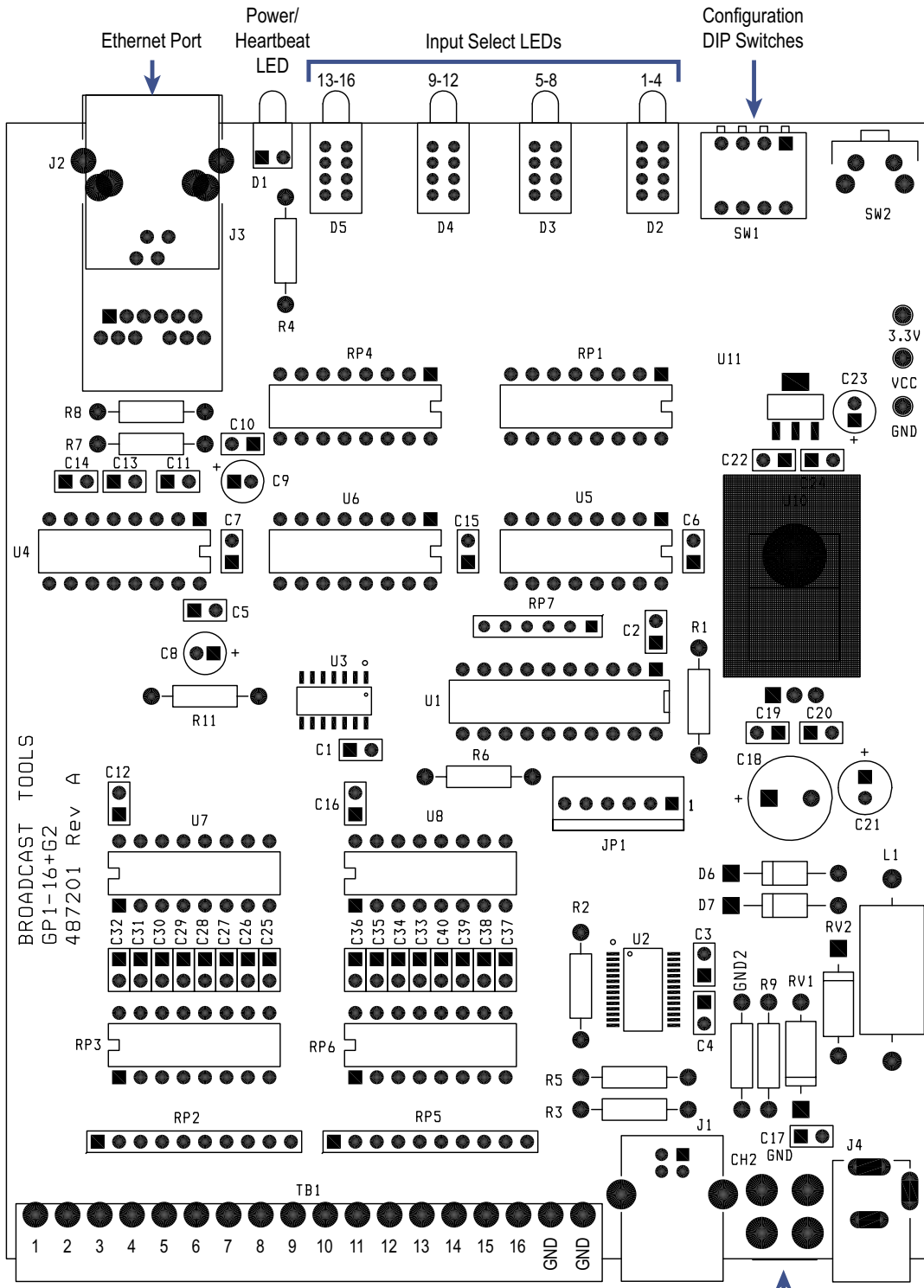

The 16 status/logic inputs may be activated either by putting the input to ground or releasing the input to a higher state. External sources can be contact closures, open connectors or 5, 12, 15 and 24-volt logic-level sources. The input impedance of each input is 22 K ohms. Supplied with plug-in Euroblock connectors.

USB Type B Port

Chassis Ground

Power 9-12VDC

APPENDIX

