

BROADCAST[®]
t o o l s **INC**
PROBLEM SOLVED

Installation and Operation Manual



DAC-1

Professional quality 24-bit stereo AES digital-to-analog audio converter.

Manual update: 12/11/2013

Firmware Version 1.01 and above. If you need a firmware upgrade, contact Broadcast Tools[®]

No part of this document may be reproduced or distributed without permission.
ALL SPECIFICATIONS AND FEATURES FOR THIS PRODUCT ARE SUBJECT TO
CHANGE WITHOUT NOTICE

NOTE: We recommend the use of Chrome, Firefox or Safari as your browser.

Due to the dynamic nature of product design, the information contained in this document is subject to change without notice. Broadcast Tools, Inc., assumes no responsibility for errors and/or omissions contained in this document. Revisions of this information or new editions may be issued to incorporate such changes.

*Broadcast Tools[®] is a registered trademark of Broadcast Tools, Inc.
tiny TOOLS[™] is a trademark of Broadcast Tools, Inc.
All Sentinel[®] labeled products are registered trademarks of Broadcast Tools, Inc.
Copyright[®] 1989 - 2013 by Broadcast Tools, Inc. All rights reserved.
No part of this document may be reproduced or distributed without permission.*

Visit www.broadcasttools.com for important product update information.

Table of Contents

Section Title	Page #
Introduction	3
Safety Information	3
Who to Contact for Help	3
Product Overview	4
Features/Benefits	4
Inspection	4
Installation/Operation	4
Surge Protection	4
UPS standby power system	4
LED indicators	5
Front Panel Controls	5
AES Digital Audio Input	5
Balanced Analog Audio Output	5
Relay and Remote Control Connections	5
Power	6
Silence Sensor/AES Error Alarm	6
Options Dip-switch setup	7
Specifications	8
Warranty	9
Front and rear panel drawings	Appendix
Connector, configuration jumpers and dip-switch layout	Appendix
Fractional schematic	Appendix

WEBSITE:
Visit our web site for product updates and additional information.

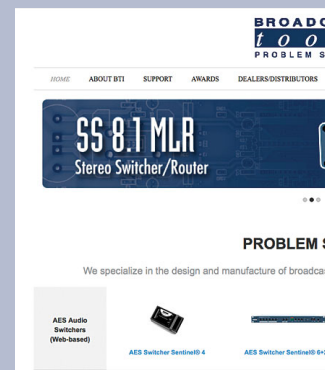

INTRODUCTION

Thank you for your purchase of a BROADCAST TOOLS® DAC-1 professional quality 24-bit stereo digital-to-analog audio converter (referred to as the DAC-1 throughout this manual). We're confident that this product will give you many years of dependable service. This manual is intended to give you all the information needed to install and operate the BROADCAST TOOLS® DAC-1.

SAFETY INFORMATION

Only qualified technical personnel should install the DAC-1. Any attempt to install this device by a person who is not technically qualified could result in a hazardous condition to the installer or other personnel or damage to the DAC-1 or other equipment. Please ensure that proper safety precautions have been taken before installing this device. If you are unfamiliar with this type of equipment, please contact a properly qualified engineer to handle the installation and setup of the DAC-1. Broadcast Tools, Inc., is unable to support NON-Broadcast Tools software, hardware or NON-Broadcast Tools computer/hardware/software problems. If you experience these problems, please research your hardware/software instruction manuals or contact the manufacturers technical support department.

WHO TO CONTACT FOR HELP

If you have any questions regarding your product or you need assistance, please contact your distributor from whom you purchased this equipment. If you would like more information about BROADCAST TOOLS® products, you may reach us at:

Broadcast Tools, Inc.

131 State Street
Sedro-Woolley, WA 98284-1503 USA
Voice: 360.854.9559
Fax: 866.783.1742

Internet Home Page: www.broadcasttools.com
E-mail: support@broadcasttools.com

**THANK YOU FOR CHOOSING
BROADCAST TOOLS® BRAND PRODUCTS!**

Broadcast Tools is a Veteran Owned Business



Designed, Assembled and Supported in WA State, USA



CAUTION!

Broadcast Tools® Products, as with any electronic device, can fail without warning. Do not use this product in applications where a life threatening condition could result due to failure.



NOTE:

This manual should be read thoroughly before installation and operation.

WEBSITE:

Visit our web site for product updates and additional information.

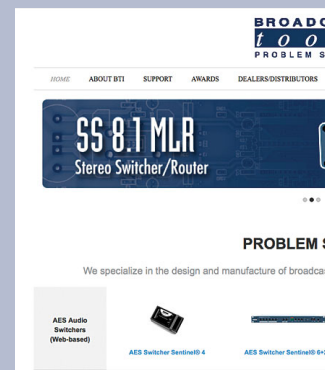

INTRODUCTION

Product Overview

The DAC-1 is a professional quality 24-bit stereo digital-to-analog audio converter. The AES input and analog stereo output are supplied on XLR connectors. The digital input signal is converted to analog audio with a 24-bit digital to analog converter and output at balanced professional levels. Sample rates of 32kHz, 44.1kHz or 48kHz are automatically selected based on the detected input source sample rate. The DAC-1 is equipped with a SPDT/SPST alarm relay, configured to close after a user defined time delay when either an analog silence sense and/or an AES error is detected. This function is user defined.

Features/Benefits

- AES input and balanced stereo output on XLR connectors
- Front panel headphone jack and level control.
- Internal silence sensor with front panel LED indicators, SPDT/SPST alarm tally relay, adjustable alarm threshold level, delay duration and restore duration.
- Alarm disable control
- Front panel sample rate and digital error indicators
- LED level meter
- DIP-switch selection of alarm time delay and restore timing delay
- Fully RFI proofed.
- Surge protected internal power supply, PS-1515 universal switching +/-15VDC power supply with domestic connectors supplied. International AC connectors optional.
- Up to three units may be mounted on the optional RA-1 rack shelf. Desktop and wall mounting is also possible.

Inspection

Please examine your DAC-1 carefully for any damage that may have been sustained during shipping. If any damage is present, please notify the shipper immediately and retain the packaging for inspection by the shipper. The package should contain the DAC-1, and a +/-15 VDC wall power supply with domestic connector. Manuals may be downloaded from our web site.

Installation

Surge Protection

The DAC-1 has built-in resistance to voltage changes; we recommend that you use a power surge protector or line conditioner on the incoming AC line. Lightning strikes and/or other high voltage surges may damage your DAC-1 and connected equipment if it is not properly protected. For lightning protection devices, check out www.polyphaser.com and www.itwlinx.com.

UPS Standby Power System

We recommend that you connect your DAC-1 to a UPS system. A UPS helps minimize the risk to the DAC-1 and provides power during a power outage.

WEBSITE:

Visit our web site for product updates and additional information.

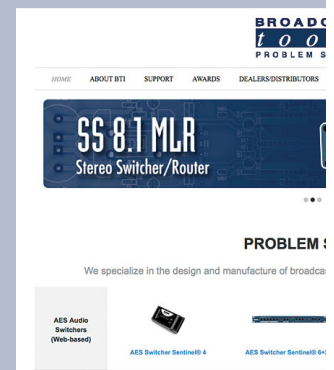

LED indicators

- “PWR/HB” LED: Illuminates when power is applied and flashes to indicate microprocessor operation.
- “48k, 44.1k, and 32k” LEDs: Indicate current AES input sample rate. 48khz, 44.1khz, or 32khz.
- “ALM Disable”: Light when alarms are disabled via local or remote control.
- “Lt Act & Rt Act” LED’s: Real-time audio activity indicators. Each channel is lit when audio output is above threshold.
- “SS” LED: Silence Sensor indicator, lit when silence is detected. The silence sensor must be enabled for this to function.
- “Err.” LED: Lit when an AES error is detected.
- “LT” and “RT”: Left and right audio level metering.

Front Panel Controls

“OPTIONS”: Ten position configuration dip-switch, see the “Options dip-switch” section of this manual for setup information.

“ALM Disable”: Recessed Alarm disable toggle switch. When toggled on alarms will be disabled and the “ALM Disable” LED will be lit.

“HdPh LVL”: Headphone output level control, adjacent to ¼” stereo headphone jack.

AES Digital Audio Input

Connect your AES output to the rear panel female XLR connector. The default input impedance 110 ohms for use with balanced AES3. This may be changed to 75 ohms or no termination by adjusting the jumper JP1. The DAC-1 must be disassembled to access JP1. To disassemble, remove all cables and power. Remove the four front and rear panel Philips head screws. Slide out the PC board, move the jumper to the desired position and reverse the operation to re-assemble the DAC-1.

Balanced Analog Audio Output

The DAC-1 provides a balanced analog stereo output on male XLR connectors. The left and right output level is adjustable via rear panel 15-turn trimmers labeled “LT OP Adjust” and “RT OP Adjust”. From the factory the analog audio output level is set at +4dBu out for -20dBfs AES input.

The output connector pin-out conforms to the 3-pin XLR Wiring Standards: Pin 1 = Ground. Pin 2 = Positive. Pin 3 = Negative.

Relay and Remote Control Connections

(TB1 Top/K1B)

EN (Enable)	GND (K1B-CM)	NO (K1B-NO)
NC (K1A-NC)	CM (K1A-CM)	NO (K1A-NO)

(TB1 Bottom/K1A)

The alarm tally relay and remote control connections are found on two three-position plugin euroblock screw terminals. The DAC-1 has one SPDT alarm relay and one SPST alarm relay labeled K1A and K1B respectively. Connections for K1A should be made on the K1A NO (normally open), CM (common) and NC (normally closed) terminals. K1B connection should be made to the K1B CM (common) and NO (normally open). Limit contact current to 1 amp at 30 VDC.

Remote alarm Enable/Disable. When the EN terminal is connected to the GND (ground) terminal the DAC-1's alarm functionality will be disabled. This input operates parallel to the front panel ALM Disable toggle switch.

Power

Connect the supplied PS-1515 power supply 3-pin AMP-style latching power connector to the unit and the +/-15 VDC switching power supply with domestic connector into a 120 Vac 50-60 Hz power source. International AC input power plug adapters are optional.

NOTE: Never use any type of power supply other than the specified/supplied power supply.

Silence Sensor/AES Error Alarm

The DAC-1's output has a built-in silence detector that monitors the stereo output of the DAC and triggers an alarm when one or both outputs fall below the user defined level. The factory default delay is set at 2 seconds, with a threshold of -20 dB below zero reference, while the restore time is set to OFF. Upon silence detection (when enabled), the ALARM Relay will close and the SS LED will illuminate for the duration of the silence. The sensor may be programmed for the following conditions:

- Silence sense threshold. The audio level below which is consider silence. This may be set to -20 dBu, -25 dBu, -30 dBu or -35 dBu.
- Number of seconds of silence that must be present before an alarm state is reached (Delay.)
- Number of seconds that valid audio must be present before an alarm state is cleared (Restore delay).

For situations where silence detection is not necessary, the DAC-1 can be operated in "AES Error Alarm" mode, where AES errors such as loss of clock will trigger the ALARM Relay in accordance with the alarm and restore delay time settings.

WEBSITE:

Visit our web site for product updates and additional information.

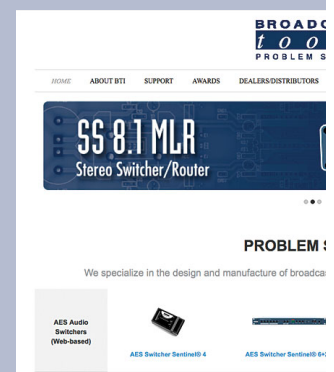

Options dip-switch

The silence sensor and alarm relay behavior is configured using the front panel Options dip-switch (SW1).

Delay Time (SW1-9 ON)	SW1-1	SW1-2	SW1-3	SW1-4	Restore Delay Time	SW1-5	SW1-6	Delay Resolution	SW1-9
OFF / Instant	OFF	OFF	OFF	OFF	OFF/Instant	OFF	OFF	2 seconds	OFF
2 Sec (20 Sec)	ON	OFF	OFF	OFF	5 seconds	ON	OFF	20 seconds	ON
4 Sec (40 sec)	OFF	ON	OFF	OFF	30 seconds	OFF	ON		
6 Sec (1 Minute)	ON	ON	OFF	OFF	90 seconds	ON	ON		
8 Sec (1 Minute, 20 sec)	OFF	OFF	ON	OFF				Mode Select	SW1-10
10 Sec (1 Minute, 40 sec)	ON	OFF	ON	OFF				Silence Alarm*	OFF
12 Sec (2 Minutes)	OFF	ON	ON	OFF	Trip Level	SW1-7	SW1-8	AES Error Alarm	ON
14 Sec (2 Minutes, 20 sec)	ON	ON	ON	OFF	- 20dB	OFF	OFF		
16 Sec (2 Minutes, 40 sec)	OFF	OFF	OFF	ON	- 25dB	ON	OFF		
18 Sec (3 Minutes)	ON	OFF	OFF	ON	- 30dB	OFF	ON		
20 Sec (3 Minutes, 20 sec)	OFF	ON	OFF	ON	- 35dB	ON	ON		
22 Sec (3 Minutes, 40 sec)	ON	ON	OFF	ON					
24 Sec (4 Minutes)	OFF	OFF	ON	ON					
26 Sec (4 Minutes, 20 sec)	ON	OFF	ON	ON					
28 Sec (4 Minutes, 40 sec)	OFF	ON	ON	ON					
30 Sec (5 Minutes)	ON	ON	ON	ON					

Note: After changing any dip-switch, please repower the unit.

Note: * Denotes factory setting.

Note: For wiring information, refer to the grids in this section of the manual, the silk-screen text on the rear panel of the product or the fractional schematic in the appendix.

SPECIFICATIONS

Digital Inputs:	AES3, XLR-F
Sample Rate:	Automatic selection, 32kHz, 44.1kHz, 48kHz.
D/A resolution:	24 bits, 128X oversampling
Analog Output:	0dBFS produces +24dBm (600 ohm load) balanced floating via XLR-M.
Distortion:	112dB A WTD THD: <.044% reference -1dBFS (20Hz – 20kHz, fs >= 44.1kHz)
Frequency Response:	+/- .20dB (20Hz – 20kHz, fs >= 44.1kHz)
Power:	PS-1515 universal switching power supply with domestic AC connector supplied. International AC connectors optional. +/-15 VDC 400mA output with 3-pin AMP-style latching power connector.
Dimensions:	5.66" x 7.00" x 1.58", Painted aluminum chassis w/ 4 - 4-40 mounting holes.

WEBSITE:

Visit our web site for product updates and additional information.

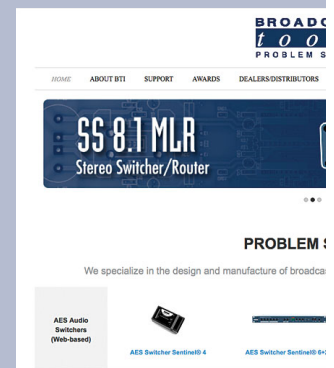

LIMITED WARRANTY

The term “Buyer” as used in this document refers to and includes both (but only) (a) any person or entity who acquires such an item for the purpose of resale to others (i.e., a dealer or distributor of an item), and (b) the first person or entity who acquires such an item for such person’s or entity’s own use.

Broadcast Tools warrants to each Buyer of any item manufactured by Broadcast Tools that the item will be free from defects in materials and workmanship at the time it is shipped by Broadcast Tools if the item is properly installed, used and maintained.

EXCLUSIVE REMEDIES

If Broadcast Tools is notified, in writing, of a failure of any item manufactured by Broadcast Tools to conform to the foregoing Limited Warranty within one (1) year following the date of the Buyer’s acquisition of the item, and if the item is returned to Broadcast Tools in accordance with Broadcast Tools’ instructions for confirmation by inspection of the defect (which at Broadcast Tools’ election may include, without limitation, a requirement that the Buyer first obtain a Return Authorization number from Broadcast Tools, that the Buyer furnish proof of purchase in the form of an invoice and/or receipt, and that the Buyer prepay all freight charges associated with any return of the item to Broadcast Tools using such freight service as Broadcast Tools reasonably may specify), Broadcast Tools will repair or replace the defective item, or will refund the purchase price paid by the Buyer for the item. Broadcast Tools shall have the exclusive right to choose between these alternative remedies.

NO OTHER WARRANTIES OR REMEDIES

TO THE MAXIMUM EXTENT PERMITTED BY APPLICABLE LAW, BROADCAST TOOLS AND ITS SUPPLIERS DISCLAIM ALL OTHER WARRANTIES, EITHER EXPRESS OR IMPLIED, INCLUDING BUT NOT LIMITED TO IMPLIED WARRANTIES OF MERCHANTABILITY OR FITNESS FOR A PARTICULAR PURPOSE; AND THE FOREGOING ALTERNATIVE REMEDIES SHALL BE EXCLUSIVE OF ALL OTHER REMEDIES. THIS LIMITED WARRANTY GIVES YOU SPECIFIC LEGAL RIGHTS. YOU MAY HAVE OTHER RIGHTS, WHICH VARY FROM STATE/JURISDICTION TO STATE/JURISDICTION.

NO LIABILITY FOR CONSEQUENTIAL DAMAGES

TO THE MAXIMUM EXTENT PERMITTED BY APPLICABLE LAW, NEITHER BROADCAST TOOLS NOR ANY OF ITS SUPPLIERS SHALL HAVE ANY LIABILITY FOR ANY SPECIAL, INCIDENTAL, INDIRECT, CONSEQUENTIAL OR PUNITIVE DAMAGES WHATSOEVER (INCLUDING, WITHOUT LIMITATION, ANY DAMAGES FOR LOST PROFITS, BUSINESS INTERRUPTION, LOSS OF DATA OR INFORMATION, COST OF CAPITAL, CLAIMS OF CUSTOMERS, OR ANY OTHER PECUNIARY LOSS) ARISING OUT OF THE USE OF OR THE INABILITY TO USE ANY ITEM SUPPLIED BY BROADCAST TOOLS, EVEN IF BROADCAST TOOLS HAS BEEN ADVISED OF THE POSSIBILITY OF SUCH DAMAGES HAVE ANY LIABILITY FOR ANY SPECIAL, INCIDENTAL, CONSEQUENTIAL, EXEMPLARY OR PUNITIVE DAMAGES. THIS LIMITATION OF LIABILITY APPLIES WHETHER A CLAIM IS ONE ALLEGING BREACH OF A CONTRACT OR WARRANTY, NEGLIGENCE OR OTHER TORT, FOR THE VIOLATION OF ANY STATUTORY DUTY, THE FAILURE OF ANY LIMITED OR EXCLUSIVE REMEDY TO ACHIEVE ITS ESSENTIAL PURPOSE, OR ANY OTHER CLAIM OF ANY NATURE. BECAUSE SOME STATES AND JURISDICTIONS DO NOT ALLOW THE EXCLUSION OR LIMITATION OF LIABILITY FOR INCIDENTAL OR CONSEQUENTIAL DAMAGES, THIS LIMITATION MAY NOT APPLY TO YOU.

Broadcast Tools, Inc.

131 State Street

Sedro-Woolley, WA 98284 • USA

360.854.9559 **voice** • 866.783.1742 **fax**

support@broadcasttools.com **e-mail**

www.broadcasttools.com **website**

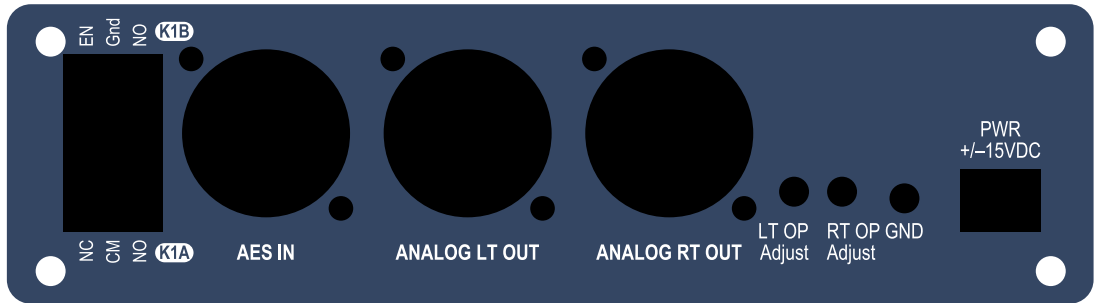
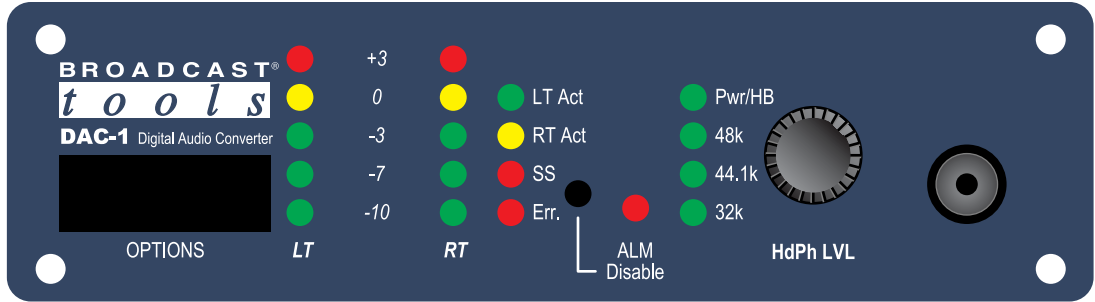

Broadcast Tools® DAC-1 Jumper and Connection Layout

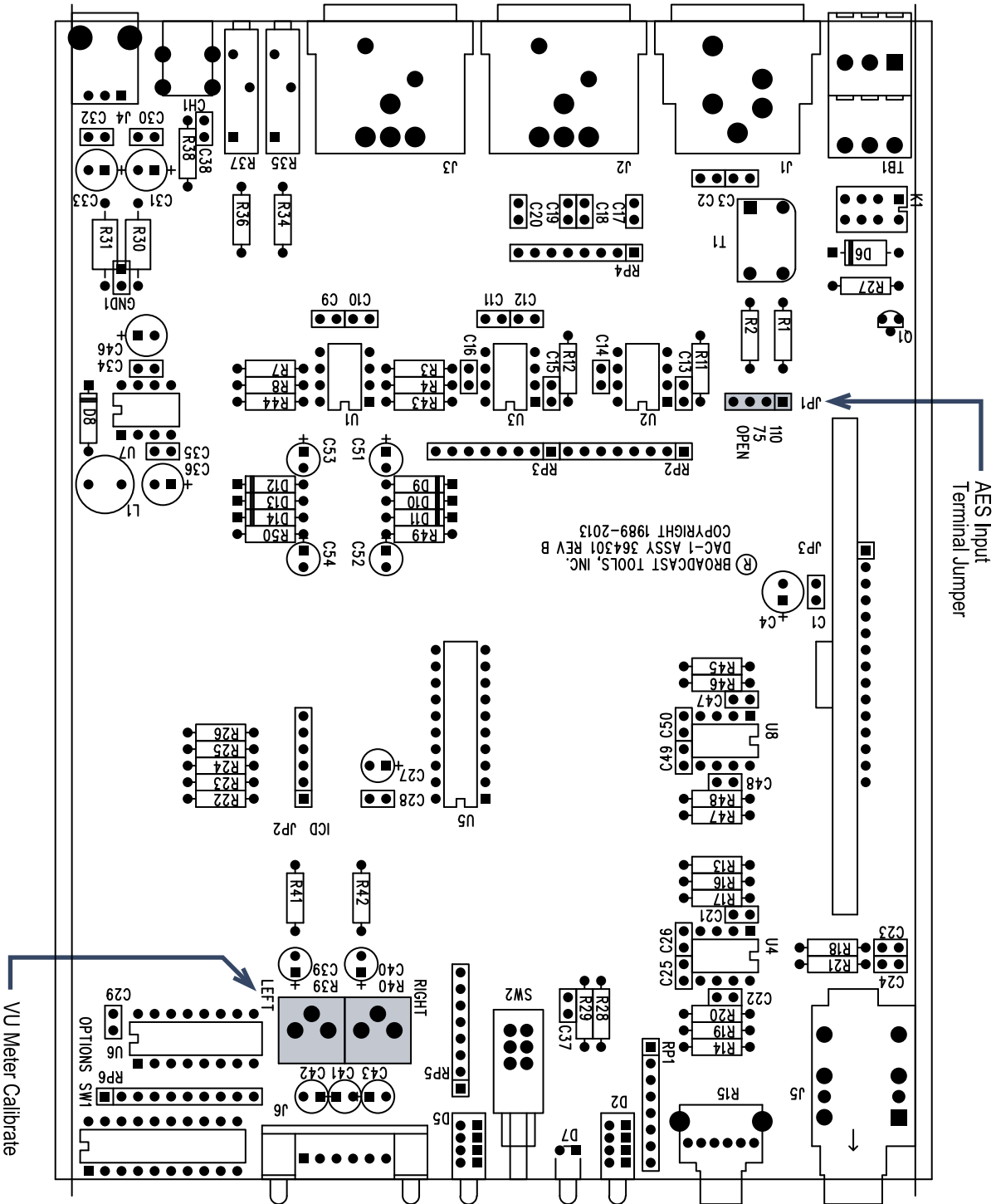

Fractional Schematic

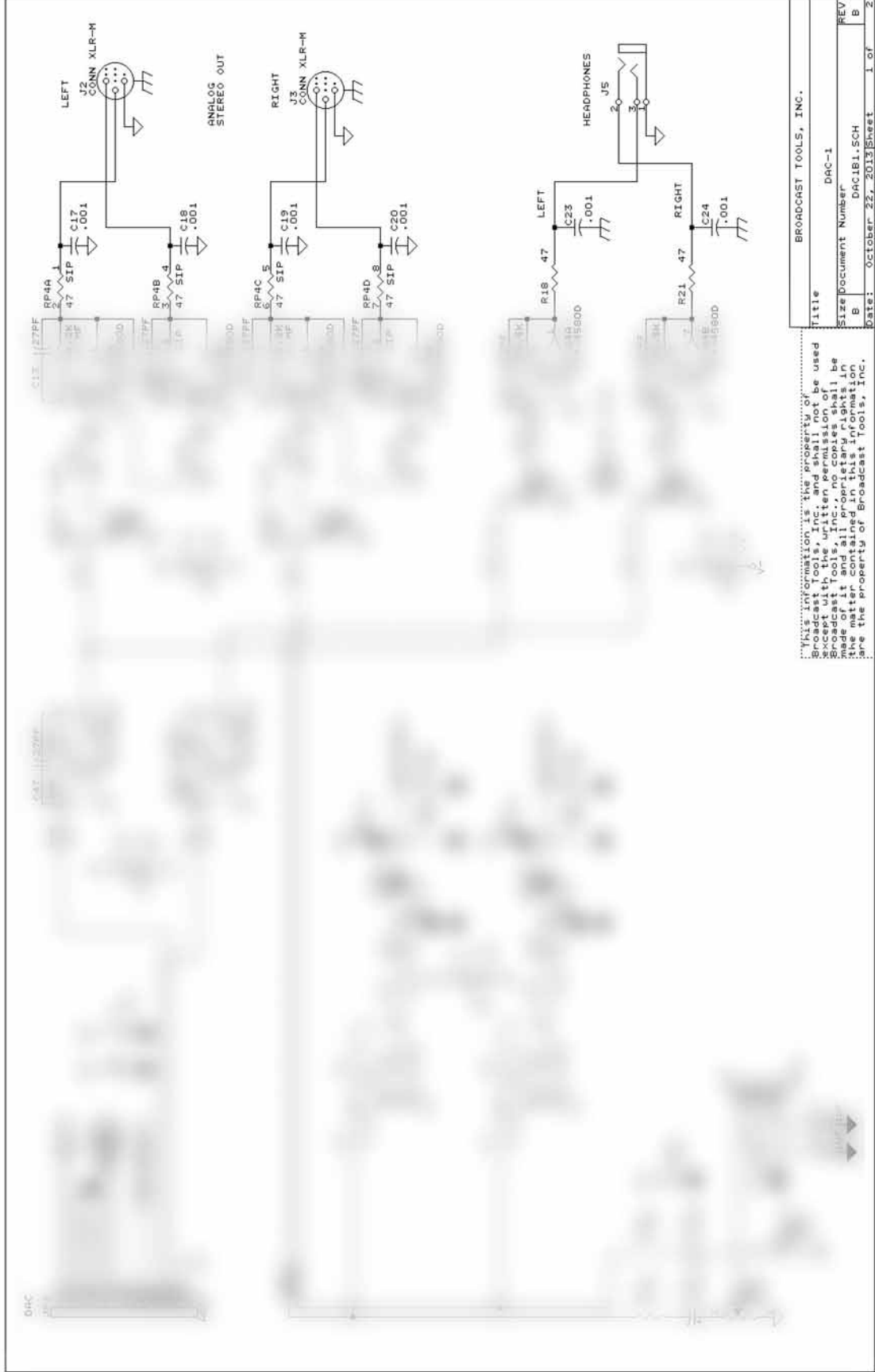

THIS INFORMATION IS THE PROPERTY OF BROADCAST TOOLS, INC. NO PART OF THIS DOCUMENT IS TO BE REPRODUCED OR TRANSMITTED IN ANY FORM OR BY ANY MEANS, ELECTRONIC OR MECHANICAL, INCLUDING PHOTOCOPYING, RECORDING, OR BY ANY INFORMATION STORAGE AND RETRIEVAL SYSTEM, WITHOUT THE WRITTEN PERMISSION OF BROADCAST TOOLS, INC. ALL RIGHTS RESERVED. THIS DOCUMENT IS THE PROPERTY OF BROADCAST TOOLS, INC. ALL RIGHTS RESERVED.

Fractional Schematic

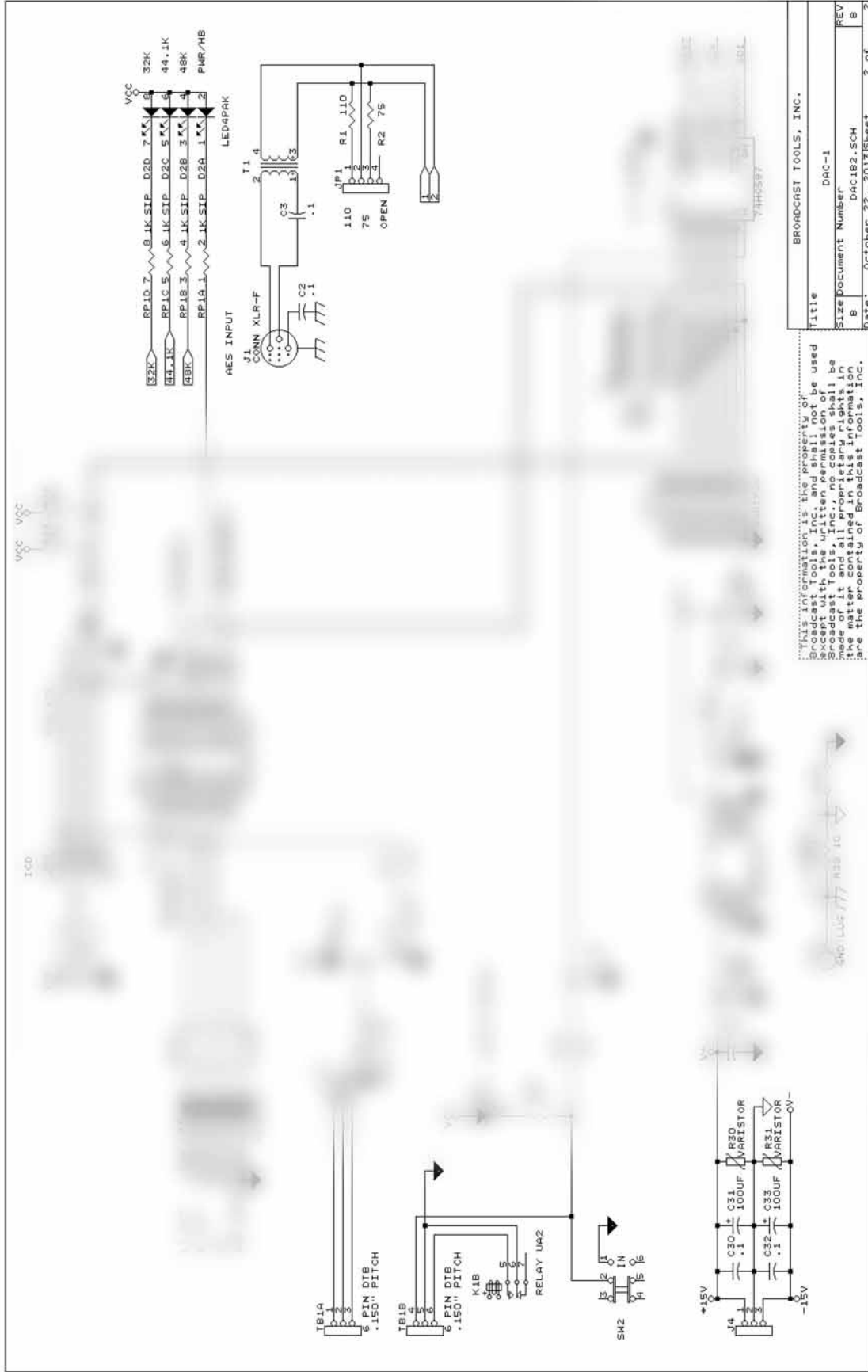

APPENDIX